

Leica Zeno GG04 plus

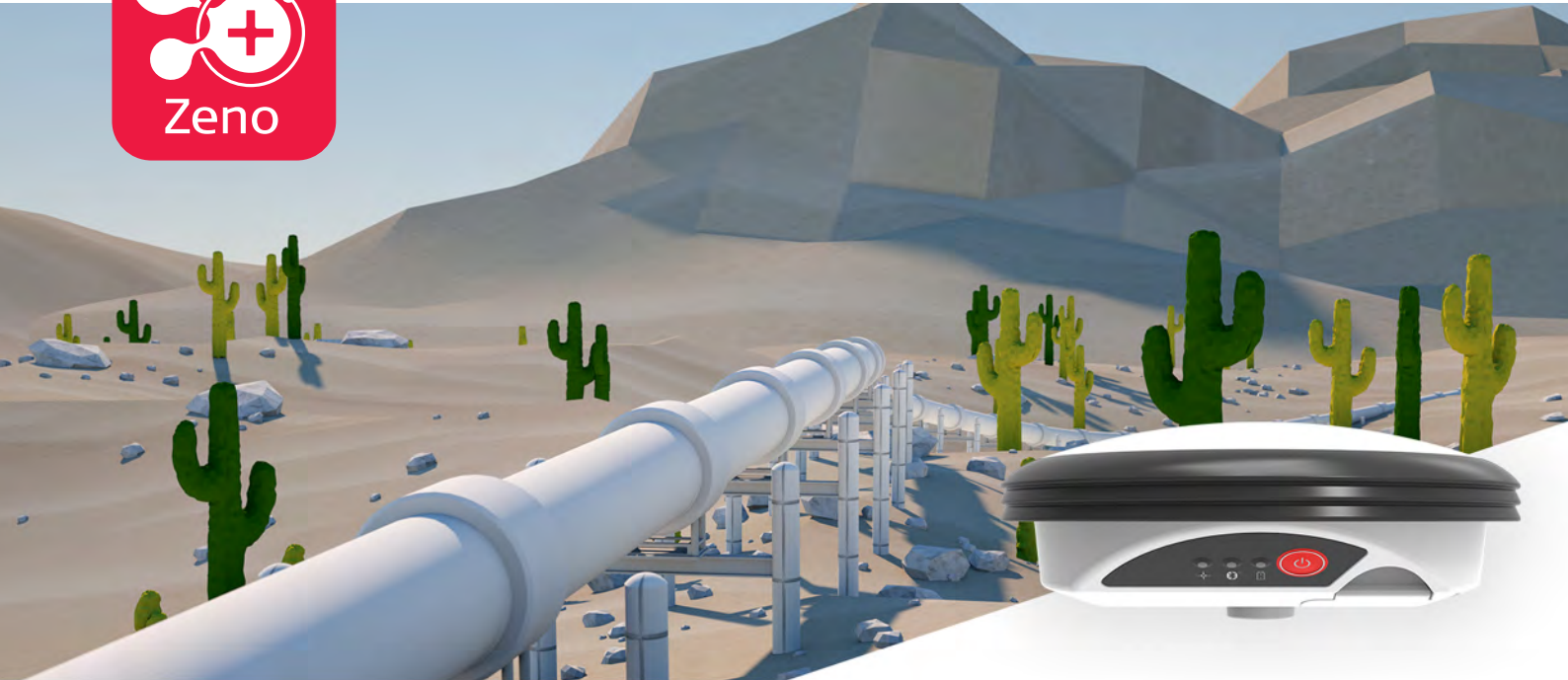

User Manual
Version 1.0
English

- when it has to be **right**

Leica
Geosystems

Introduction

Purchase

Congratulations on the purchase of the Leica Zeno GG04 plus.



This manual contains important safety directions as well as instructions for setting up the product and operating it. Refer to "1 Safety Directions" for further information.

Read carefully through the User Manual before you switch on the product.

Product identification

The model and serial number of your product are indicated on the type plate. Always refer to this information when you need to contact your agency or Leica Geosystems authorised service centre.

Trademarks



- Windows is a registered trademark of Microsoft Corporation in the United States and other countries
- *Bluetooth*[®] is a registered trademark of Bluetooth SIG, Inc.
- Android[™] is a trademark of Google Inc.
- Apple is a trademark of Apple Inc., registered in the U.S. and other countries.
- iPad, and iPhone are trademarks of Apple Inc., registered in the U.S. and other countries. iPad Air, iPad Pro, and iPad mini are trademarks of Apple Inc.
- "Made for iPhone", and "Made for iPad" mean that an electronic accessory has been designed to connect specifically to iPhone or iPad, respectively, and has been certified by the developer to meet Apple performance standards. Apple is not responsible for the operation of this device or its compliance with safety and regulatory standards. Please note that the use of this accessory with iPhone, or iPad may affect wireless performance.
- iOS is a trademark or registered trademark of Cisco in the U.S. and other countries and is used under license.

All other trademarks are the property of their respective owners.

Validity of this manual

This manual applies to all models of the Leica GG04 plus GNSS instrument. Where there are differences between the various instruments they are clearly described.

Available documentation

Name	Description/Format		
Leica GG04 plus Quick Guide	Provides an overview of the product together with technical data and safety directions. Intended as a quick reference guide.	✓	✓
Leica GG04 plus User Manual	All instructions required in order to operate the product to a basic level are contained in the User Manual. Provides an overview of the product together with technical data and safety directions.	-	✓

Refer to the myWorld web page for all GG04 plus documentation/software:

- <https://myworld.leica-geosystems.com>

myWorld@Leica Geosystems (<https://myworld.leica-geosystems.com>) offers a wide range of services, information and training material.

With direct access to myWorld, you are able to access all relevant services whenever it is convenient for you.

Service	Description
myProducts	Add all products that you and your company own and explore your world of Leica Geosystems: View detailed information on your products and update your products with the latest software and keep up-to-date with the latest documentation.
myService	View the current service status and full service history of your products in Leica Geosystems service centres. Access detailed information on the services performed and download your latest calibration certificates and service reports.
mySupport	View the current service status and full service history of your products in Leica Geosystems service centres. Access detailed information on the services performed and download your latest calibration certificates and service reports.
myTraining	Enhance your product knowledge with Leica Geosystems Campus - Information, Knowledge, Training. Study the latest online training material on your products and register for seminars or courses in your country.
myTrustedServices	Add your subscriptions and manage users for Leica Geosystems Trusted Services, the secure software services, that assist you to optimise your workflow and increase your efficiency.

Table of Contents

1	Safety Directions	5
1.1	General Introduction	5
1.2	Definition of Use	6
1.3	Limits of Use	6
1.4	Responsibilities	6
1.5	Hazards of Use	7
1.6	Electromagnetic Compatibility EMC	12
1.7	FCC Statement, Applicable in U.S.	13
1.8	ICES-003 Statement, Applicable in Canada	14
2	Description of the System	15
2.1	General Information	15
2.2	System Components	15
2.3	Data Collection	17
2.4	Power Concept	17
2.5	Leica Zeno GIS Software	17
2.6	Accessories	18
3	Operation	19
3.1	Guidelines for Correct Results with GNSS Surveys	19
3.2	Batteries	19
3.2.1	Operating Principles	19
3.2.2	Battery for GG04 plus	19
3.3	Equipment Setup as a Real-Time Rover	20
3.3.1	Setup with Leica Zeno GIS Hardware and Software	20
3.3.2	Setup with Third-Party Mobile Devices	21
3.4	Connection with Leica Zeno GIS Software	22
3.5	Correction Service Spot Lite and Spot Prime (PPP)	24
4	Care and Transport	26
4.1	Transport	26
4.2	Storage	26
4.3	Cleaning and Drying	26
5	Technical Data	28
5.1	Tracking Characteristics GG04 plus	28
5.2	Accuracy	28
5.3	Technical Data	29
5.4	Conformity to National Regulations	30
5.4.1	Dangerous Goods Regulations	31
6	Software Licence Agreement	32
Appendix A	Firmware Upgrade	33
Appendix B	Pin Assignments and Sockets	34

1 Safety Directions

1.1 General Introduction

Description

The following directions enable the person responsible for the product, and the person who actually uses the equipment, to anticipate and avoid operational hazards.

The person responsible for the product must ensure that all users understand these directions and adhere to them.

About warning messages





Warning messages are an essential part of the safety concept of the instrument. They appear wherever hazards or hazardous situations can occur.

Warning messages...

- make the user alert about direct and indirect hazards concerning the use of the product.
- contain general rules of behaviour.

For the users' safety, all safety instructions and safety messages shall be strictly observed and followed! Therefore, the manual must always be available to all persons performing any tasks described here.

DANGER, WARNING, CAUTION and **NOTICE** are standardised signal words for identifying levels of hazards and risks related to personal injury and property damage. For your safety, it is important to read and fully understand the following table with the different signal words and their definitions! Supplementary safety information symbols may be placed within a warning message as well as supplementary text.

Type	Description
 DANGER	Indicates an imminently hazardous situation which, if not avoided, will result in death or serious injury.
 WARNING	Indicates a potentially hazardous situation or an unintended use which, if not avoided, could result in death or serious injury.
 CAUTION	Indicates a potentially hazardous situation or an unintended use which, if not avoided, may result in minor or moderate injury.
NOTICE	Indicates a potentially hazardous situation or an unintended use which, if not avoided, may result in appreciable material, financial and environmental damage.
	Important paragraphs which must be adhered to in practice as they enable the product to be used in a technically correct and efficient manner.

1.2

Definition of Use

Intended use

- Measuring raw data using carrier phase and code signal from GNSS satellites.
 - Computing with software.
 - Recording measurements.
 - Recording GNSS and point related data.
 - Carrying out measurement tasks using various GNSS measuring techniques.
 - Data communication with external appliances.
-

Reasonably foreseeable misuse

- Use of the product without instruction.
 - Use outside of the intended use and limits.
 - Disabling safety systems.
 - Removal of hazard notices.
 - Opening the product using tools, for example screwdriver, unless this is permitted for certain functions.
 - Modification or conversion of the product.
 - Use after misappropriation.
 - Use of products with recognizable damages or defects.
 - Use with accessories from other manufacturers without the prior explicit approval of Leica Geosystems.
 - Inadequate safeguards at the working site.
 - Controlling of machines, moving objects or similar monitoring application without additional control and safety installations.
-

1.3

Limits of Use

Environment

Suitable for use in an atmosphere appropriate for permanent human habitation: not suitable for use in aggressive or explosive environments.

DANGER

Working in hazardous areas, or close to electrical installations or similar situations.

Life Risk.

Precautions:

- ▶ Local safety authorities and safety experts must be contacted by the person responsible for the product before working in such conditions.
-

1.4

Responsibilities

Manufacturer of the product

Leica Geosystems AG, CH-9435 Heerbrugg, hereinafter referred to as Leica Geosystems, is responsible for supplying the product, including the user manual and original accessories, in a safe condition.

Person responsible for the product

The person responsible for the product has the following duties:

- To understand the safety instructions on the product and the instructions in the user manual.
- To ensure that it is used in accordance with the instructions.
- To be familiar with local regulations relating to safety and accident prevention.
- To inform Leica Geosystems immediately if the product and the application becomes unsafe.
- To ensure that the national laws, regulations and conditions for the operation of the product are respected.

1.5

Hazards of Use

DANGER

Risk of electrocution

Because of the risk of electrocution, it is dangerous to use poles, levelling staffs and extensions in the vicinity of electrical installations such as power cables or electrical railways.

Precautions:

- ▶ Keep at a safe distance from electrical installations. If it is essential to work in this environment, first contact the safety authorities responsible for the electrical installations and follow their instructions.



 **DANGER**

Risk of being struck by lightning

If the product is used with accessories, for example on masts, staffs, poles, you may increase the risk of being struck by lightning. Danger from high voltages also exists near power lines. Lightning, voltage peaks, or the touching of power lines can cause damage, injury and death.

Precautions:

- ▶ Do not use the product in a thunderstorm as you can increase the risk of being struck by lightning.
- ▶ Be sure to remain at a safe distance from electrical installations. Do not use the product directly under or close to power lines. If it is essential to work in such an environment contact the safety authorities responsible for electrical installations and follow their instructions.
- ▶ If the product has to be permanently mounted in an exposed location, it is advisable to provide a lightning conductor system. A suggestion on how to design a lightning conductor for the product is given below. Always follow the regulations in force in your country regarding grounding antennas and masts. These installations must be carried out by an authorised specialist.
- ▶ To prevent damages due to indirect lightning strikes (voltage spikes) cables, for example for antenna, power source or modem should be protected with appropriate protection elements, like a lightning arrester. These installations must be carried out by an authorised specialist.
- ▶ If there is a risk of a thunderstorm, or if the equipment is to remain unused and unattended for a long period, protect your product additionally by unplugging all systems components and disconnecting all connecting cables and supply cables, for example, instrument - antenna.

 **WARNING**

Distraction/loss of attention

During dynamic applications, for example stakeout procedures, there is a danger of accidents occurring if the user does not pay attention to the environmental conditions around, for example obstacles, excavations or traffic.

Precautions:

- ▶ The person responsible for the product must make all users fully aware of the existing dangers.

 **WARNING**

Inadequate securing of the working site.

This can lead to dangerous situations, for example in traffic, on building sites and at industrial installations.

Precautions:

- ▶ Always ensure that the working site is adequately secured.
- ▶ Adhere to the regulations governing safety, accident prevention and road traffic.

 **WARNING**

Lightning strike

If the product is used with accessories, for example masts, staffs, poles, you may increase the risk of being struck by lightning.

Precautions:

- ▶ Do not use the product in a thunderstorm.
-

 **WARNING**

Exposure of batteries to high mechanical stress, high ambient temperatures or immersion into fluids

This can cause leakage, fire or explosion of the batteries.

Precautions:

- ▶ Protect the batteries from mechanical influences and high ambient temperatures. Do not drop or immerse batteries into fluids.
-

 **WARNING**

Short circuit of battery terminals

If battery terminals are short circuited e.g. by coming in contact with jewellery, keys, metallised paper or other metals, the battery can overheat and cause injury or fire, for example by storing or transporting in pockets.

Precautions:

- ▶ Make sure that the battery terminals do not come into contact with metallic objects.
-

 **WARNING**

Incorrect fastening of the external antenna

Incorrect fastening of the external antenna to vehicles or transporters poses the risk of the equipment being broken by mechanical influence, vibration or airstream. This may result in accident and physical injury.

Precautions:

- ▶ Attach the external antenna professionally. The external antenna must be secured additionally, for example by use of a safety cord. Ensure that the mounting device is correctly mounted and able to carry the weight of the external antenna (>1 kg) safely.
-

WARNING

Improper disposal

If the product is improperly disposed of, the following can happen:

- If polymer parts are burnt, poisonous gases are produced which may impair health.
- If batteries are damaged or are heated strongly, they can explode and cause poisoning, burning, corrosion or environmental contamination.
- By disposing of the product irresponsibly you may enable unauthorised persons to use it in contravention of the regulations, exposing themselves and third parties to the risk of severe injury and rendering the environment liable to contamination.

Precautions:

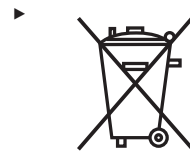

The product must not be disposed with household waste. Dispose of the product appropriately in accordance with the national regulations in force in your country. Always prevent access to the product by unauthorised personnel.

Product-specific treatment and waste management information can be received from your Leica Geosystems distributor.

WARNING

Improperly repaired equipment

Risk of injuries to users and equipment destruction due to lack of repair knowledge.

Precautions:

- ▶ Only Leica Geosystems authorised service centres are entitled to repair these products.

CAUTION

Not properly secured accessories.

If the accessories used with the product are not properly secured and the product is subjected to mechanical shock, for example blows or falling, the product may be damaged or people can sustain injury.

Precautions:

- ▶ When setting up the product, make sure that the accessories are correctly adapted, fitted, secured, and locked in position.
- ▶ Avoid subjecting the product to mechanical stress.

⚠ CAUTION

Inappropriate mechanical influences to batteries

During the transport, shipping or disposal of batteries it is possible for inappropriate mechanical influences to constitute a fire hazard.

Precautions:

- ▶ Before shipping the product or disposing of it, discharge the batteries by running the product until they are flat.
- ▶ When transporting or shipping batteries, the person in charge of the product must ensure that the applicable national and international rules and regulations are observed.
- ▶ Before transportation or shipping contact your local passenger or freight transport company.

Lightning conductors

Suggestion for design of a lightning conductor for a GNSS system:

1. On non-metallic structures
Protection by air terminals is recommended. An air terminal is a pointed solid or tubular rod of conducting material with proper mounting and connection to a conductor. The position of four air terminals can be uniformly distributed around the antenna at a distance equal to the height of the air terminal.
The air terminal diameter should be 12 mm for copper or 15 mm for aluminium. The height of the air terminals should be 25 cm to 50 cm. All air terminals should be connected to the down conductors. The diameter of the air terminal should be kept to a minimum to reduce GNSS signal shading.
2. On metallic structures
Protection is as described for non-metallic structures, but the air terminals can be connected directly to the conducting structure without the need for down conductors.

Air terminal arrangement, plan view

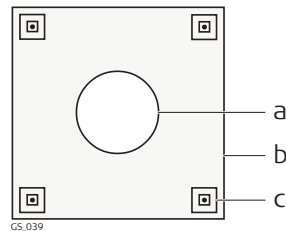

- a Antenna
- b Support structure
- c Air terminal

Grounding the instrument/antenna

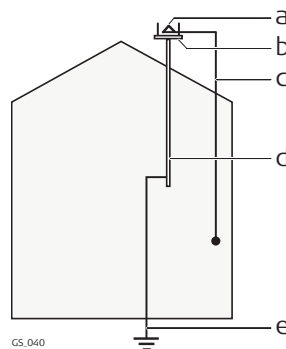

- a Antenna
- b Lightning conductor array
- c Antenna/instrument connection
- d Metallic mast
- e Connection to earth

Description

The term Electromagnetic Compatibility is taken to mean the capability of the product to function smoothly in an environment where electromagnetic radiation and electrostatic discharges are present, and without causing electromagnetic disturbances to other equipment.

⚠ WARNING**Electromagnetic radiation**

Electromagnetic radiation can cause disturbances in other equipment. Although the product meets the strict regulations and standards which are in force in this respect, Leica Geosystems cannot completely exclude the possibility that other equipment may be disturbed.

⚠ CAUTION**Use of the product with accessories from other manufacturers. For example field computers, personal computers or other electronic equipment, non-standard cables or external batteries**

This may cause disturbances in other equipment.

Precautions:

- ▶ Use only the equipment and accessories recommended by Leica Geosystems.
- ▶ When combined with the product, they meet the strict requirements stipulated by the guidelines and standards.
- ▶ When using computers, two-way radios or other electronic equipment, pay attention to the information about electromagnetic compatibility provided by the manufacturer.

⚠ CAUTION**Intense electromagnetic radiation. For example, near radio transmitters, two-way radios or diesel generators**

Although the product meets the strict regulations and standards which are in force in this respect, Leica Geosystems cannot completely exclude the possibility that function of the product may be disturbed in such an electromagnetic environment.

Precautions:

- ▶ Check the plausibility of results obtained under these conditions.

⚠ CAUTION**Electromagnetic radiation due to improper connection of cables**

If the product is operated with connecting cables attached at only one of their two ends, for example external supply cables, interface cables, the permitted level of electromagnetic radiation may be exceeded and the correct functioning of other products may be impaired.

Precautions:

- ▶ While the product is in use, connecting cables, for example product to external battery, product to computer, must be connected at both ends.

WARNING

Use of the product with Bluetooth

Electromagnetic radiation can cause disturbances in other equipment, in installations, in medical devices, for example pacemakers or hearing aids and in aircraft. It can also affect humans and animals.

Precautions:

- ▶ Although the product meets in combination with radio or digital cellular phone devices recommended by Leica Geosystems the strict regulations and standards which are in force in this respect, Leica Geosystems cannot completely exclude the possibility that other equipment may be disturbed or that humans or animals may be affected.
- ▶ Do not operate the product with radio or digital cellular phone devices in the vicinity of filling stations or chemical installations, or in other areas where an explosion hazard exists.
- ▶ Do not operate the product with radio or digital cellular phone devices near to medical equipment.
- ▶ Do not operate the product with radio or digital cellular phone devices in aircraft.

1.7

FCC Statement, Applicable in U.S.

WARNING

This equipment has been tested and found to comply with the limits for a Class B digital device, pursuant to part 15 of the FCC rules.

These limits are designed to provide reasonable protection against harmful interference in a residential installation.

This equipment generates, uses and can radiate radio frequency energy and, if not installed and used in accordance with the instructions, may cause harmful interference to radio communications. However, there is no guarantee that interference will not occur in a particular installation.

- Reorient or relocate the receiving antenna.
- Increase the separation between the equipment and the receiver.
- Connect the equipment into an outlet on a circuit different from that to which the receiver is connected.
- Consult the dealer or an experienced radio/TV technician for help.

CAUTION

Changes or modifications not expressly approved by Leica Geosystems for compliance could void the user's authority to operate the equipment.

Labelling GG04 plus



Labelling internal battery GEB212

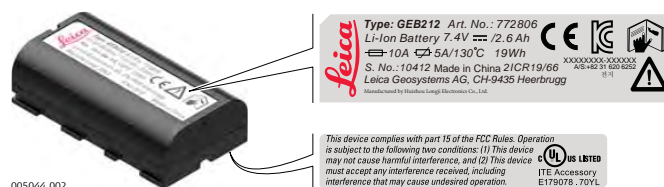

1.8

ICES-003 Statement, Applicable in Canada

WARNING

This Class (B) digital apparatus complies with Canadian ICES-003.
Cet appareil numérique de la classe (B) est conforme à la norme NMB-003 du Canada.

Canada Compliance Statement

This device complies with Industry Canada's license-exempt RSSs. Operation is subject to the following two conditions:

1. This device may not cause interference; and
2. This device must accept any interference, including interference that may cause undesired operation of the device.

Canada Déclaration de Conformité

Le présent appareil est conforme aux CNR d'Industrie Canada applicables aux appareils radio exempts de licence. L'exploitation est autorisée aux deux conditions suivantes:

1. l'appareil ne doit pas produire de brouillage;
2. l'appareil doit accepter tout brouillage radioélectrique subi, même si le brouillage est susceptible d'en compromettre le fonctionnement.

2

Description of the System

2.1

General Information

Design

The instrument

- Is designed to be used on a pole. It calculates a position from the computed ranges to all visible and activated GNSS (Global Navigation Satellite System) satellites.
 - Can be used with any existing Leica Zeno GIS hardware, like the CS25, CS25 plus, CS25 GNSS, CS25 LRBT, Zeno 5, Zeno 10, Zeno 15 or with the following third-party hardware in combination with Zeno Connect:
 - Selected Android phones with Android version > 4.1,
 - Selected Android tablets with Android version > 4.1,
 - Windows 7/8/10 PC/Laptop,
 - Compatible with iPhone, and iPad.
 - Can communicate with Leica Zeno GIS software:
 - Zeno Mobile,
 - Zeno Connect (compatible with Windows 7/8/10, Android version > 4.1 or iPhone, and iPad), or
 - Zeno Field
 - With the help of Zeno Connect can be used with third-party applications.
 - Can be configured to track all currently available satellite systems with all included signals (multi-frequency and multi-satellite system).
 - Can increase positioning accuracy through various correction services, like SBAS, RTCM corrections or Spot options (Precise Point Positioning - PPP - coming by L-band satellites).
 - Can provide NMEA messages output on different Bluetooth ports to allow reviewing and storing of GNSS metadata information.
-

Special features

The instrument contains several special features:

- Robust instrument with integrated antenna and built-in ground plane.
 - Low power consumption.
 - Simple mounting.
 - Seamless integration with all available Leica Zeno GIS software.
 - LED indicators for power, Bluetooth and signal reception.
 - Multiple upgrade options.
-

Firmware concept

The instrument is delivered with the latest firmware version installed. If a new firmware version is released at a later point in time, use the Leica Zeno GIS software on Windows to upload this version by a Bluetooth connection.

Refer to "A Firmware Upgrade" for firmware upgrade of the instrument.



To ensure best tracking performance, verify to have the most recent Leica Zeno GIS firmware installed on the instrument.

2.2

System Components

Main components

The GG04 plus represents the so called instrument.

Component	Description
Integrated antenna	Receiving signals from a GNSS (Global Navigation Satellite System).
Bluetooth	To wireless pair with Leica Zeno GIS or third-party hardware.

Component	Description
Battery	The battery compartment holds the GEB212 battery for power supply.
LEDs	Indication of power, Bluetooth and signal reception.
LEMO-1 connector	Serial by RS232 or USB communication.
5/8" Whitworth thread	Mounting the instrument for observation.

Interface

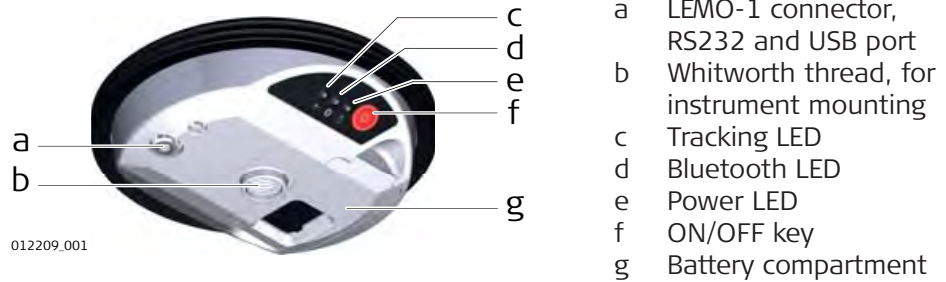

Do not open the instrument or remove any connector as this action impairs the protection against water, dust and sand. Open the instrument for battery handling without exception in dry and clean conditions only.

LED Indicators

The GG04 plus has Light Emitting Diode indicators. They indicate the basic instrument status.

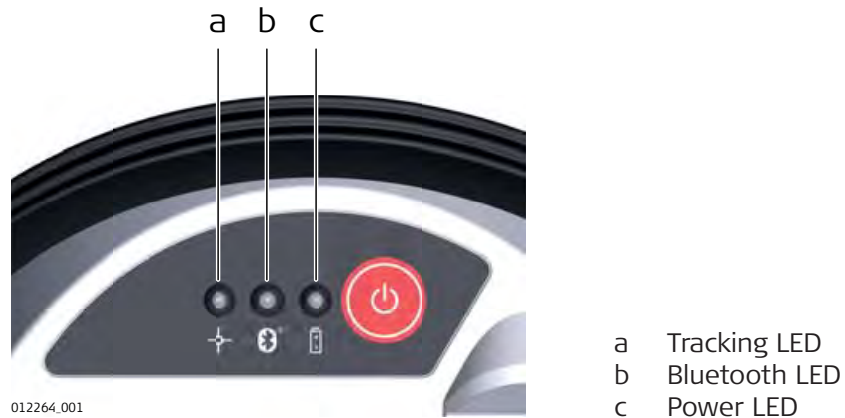

Description of the LEDs

LED	LED Status	Status of the Instrument
Tracking	Green	Enough satellites tracked to compute position.
	Dark	No position computed.
Bluetooth	Green	The antenna is ready to be connected to.
	Blue	Connection established to a Bluetooth device.
Power	Off	Power is off.
	Green	Power level is good.

LED	LED Status	Status of the Instrument
	Red	Power level is low.
	Flashing red	Power level is critical.

2.3

Data Collection

Live and raw data collection

The instrument can be connected with Leica Zeno GIS software and Leica Zeno hardware or selected Android, iOS or Windows software and devices to collect or verify assets in the field and to collect raw data. Our software and office software fully supports the collected GG04 plus data either to review and adapt or to post-process collected raw data. The setting for the GG04 plus Smart Antenna can be adjusted with different provided tools.

2.4

Power Concept

General

Use the batteries, chargers and accessories recommended by Leica Geosystems to ensure the correct functionality of the instrument.

Power options

Power for the instrument can be supplied internally only.
Internal power supply: One battery (GEB212) fits into the instrument.

On/Off behaviour

- On: The instrument turns on as soon as the power supply is connected and the power key is pressed.
- Off: To turn off the instrument push either the power key or disconnect the power supply.

Total discharge

If an instrument connected to a low powered external battery continues to operate, total discharge of the battery can occur.

2.5

Leica Zeno GIS Software

Description

All Leica Zeno GIS hardware and software can utilise the GG04 plus with a survey pole. The compatible hardware includes the Zeno 5, Zeno 10, Zeno 15, CS25, CS25 plus, CS25 GNSS, CS25 LRBT and selected Android, iOS or Windows devices.

With the Leica Zeno GIS software you can do different things:

- Seamlessly connect to the GG04 plus Smart Antenna through Bluetooth.
- Compute positions.
- Configure the Smart Antenna.
- Collect raw data from the Smart Antenna.
- Collect live data.
- Configure RTK connections to improve positioning accuracy.
- Export collected data in different formats.

Refer to the respective software documentation for further information.

Software to utilise the instrument

A Leica Zeno Connect license for third-party Android or iOS devices is already included with the purchase of the instrument. Leica Zeno Connect for third-party devices can be found in the corresponding App Stores.

All further available and supported software can be purchased from Leica Geosystems AG.

2.6

Accessories

Description

Extra equipment such as cables and universal pole holders are listed in the setup sections. Any further description of accessories is not part of this manual.

Refer to the Leica Zeno GIS Equipment List.

3 Operation

3.1 Guidelines for Correct Results with GNSS Surveys

Undisturbed satellite signal reception

Successful GNSS measurements require undisturbed satellite signal reception. For kinematic use, be sure to select measurement positions with best satellite reception possible. Use the instrument in location which is free of obstructions such as trees, buildings or mountains for best measurement results.

Centred instrument

Centre the instrument precisely over the target positions.

3.2 Batteries

3.2.1 Operating Principles

First-time use/charging batteries

- The battery must be charged before using it for the first time because it is delivered with an energy content as low as possible.
- The permissible temperature range for charging is from 0 °C to +40 °C/ +32 °F to +104 °F. For optimal charging, we recommend charging the batteries at a low ambient temperature of +10 °C to +20 °C/+50 °F to +68 °F if possible.
- It is normal for the battery to become warm during charging. Using the chargers recommended by Leica Geosystems, it is not possible to charge the battery once the temperature is too high.
- For new batteries or batteries that have been stored for a long time (> three months), it is effectual to make only one charge/discharge cycle.
- For Li-Ion batteries, a single discharging and charging cycle is sufficient. We recommend carrying out the process when the battery capacity indicated on the charger or on a Leica Geosystems product deviates significantly from the actual battery capacity available.

Operation/discharging

- The batteries can be operated from -20 °C to +55 °C/-4 °F to +131 °F.
- Low operating temperatures reduce the capacity that can be drawn; high operating temperatures reduce the service life of the battery.

3.2.2 Battery for GG04 plus

Change battery step-by-step

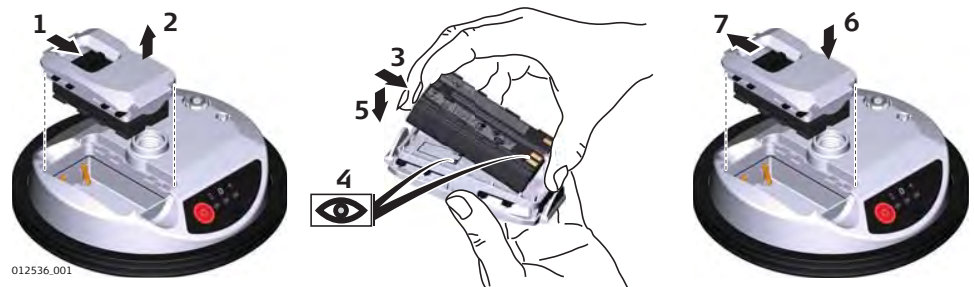

Turn the GG04 plus over to gain access to the battery compartment.

1. Push the slide fastener in the direction of the arrow with the open-lock symbol.
2. Open the battery compartment.
3. Pull the battery from the battery compartment.

4. A pictogram of the battery is displayed inside the battery compartment. It is a visual aid to help in placing the battery correctly.
5. Place the battery into the battery compartment, ensuring that the contacts are facing outward. Click the battery into position.
6. Close the battery compartment.
7. Lock the battery compartment by pushing the slide fastener in the direction of the arrow with the close-lock symbol.

3.3 Equipment Setup as a Real-Time Rover

3.3.1 Setup with Leica Zeno GIS Hardware and Software

Use

The equipment setup is used for real-time rover with extended periods of use in the field.

Description

This chapter shows a possible pole setup with Leica Zeno GIS hardware and software.

Connection between the GG04 plus instrument and the field controller is made through Bluetooth. All hardware is fixed on a Leica carbon pole in this example.



- The antenna is mounted directly using screw fitting.
- Carbon fibre poles are used. They can be replaced with their aluminium equivalent without any change to these instructions.

Equipment setup

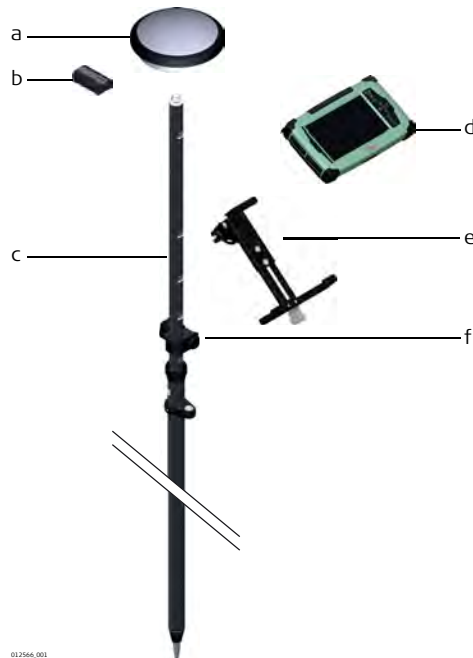

- a GG04 plus
- b GEB212 battery
- c Pole
- d CS25 plus or Zeno 5 field controller
- e AZ204, GHT55 or GHT72 pole holder
- f GHT63 pole clamp

Equipment setup step-by-step

Step	Description
------	-------------

- | | |
|----|--|
| 1. | Attach the GHT63 pole clamp to the pole. |
|----|--|

Step	Description
2.	Attach the correct pole holder to the clamp, according to the field controller: <ul style="list-style-type: none"> the GHT72 pole holder for the CS25 plus controller the GHT55 pole holder for the Zeno 5 controller
3.	Clip the field controller into the holder and lock it by pushing the locking pin into the locked position.
4.	Insert the battery into the field controller.
5.	Press the ON/OFF key on the field controller to switch on.
6.	Insert the battery into the GG04 plus.
7.	Press the ON/OFF key on the GG04 plus to switch on.
8.	Screw the GG04 plus to the top of the pole.
9.	Start the Zeno GIS software on the controller and select the GG04 plus instrument to be connected through Bluetooth.

3.3.2

Setup with Third-Party Mobile Devices

Use

The equipment setup is used for real-time rover with extended periods of use in the field with a third-party Android, iOS or Windows mobile device.

Description

This chapter shows a possible pole setup of the GG04 plus with a third-party hardware and Zeno Connect to utilise the position in a third-party software. Connection between the GG04 plus instrument and the mobile device is made through Bluetooth. All hardware is fixed on a Leica carbon pole in this example.



- The antenna is mounted directly using screw fitting.
- Carbon fibre poles are used. They can be replaced with their aluminium equivalent without any change to these instructions.

Equipment setup

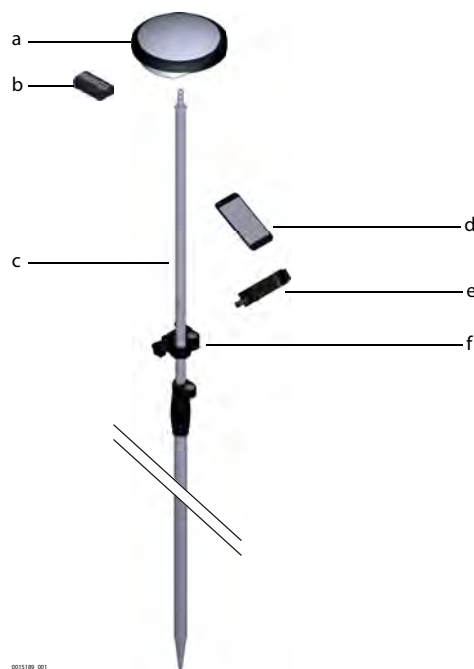

- a GG04 plus
- b GEB212 battery
- c Pole
- d Mobile device
- e UVPMLPH Universal Pole Mount large Smartphones

Equipment setup step-by-step

1. Attach the correct pole holder, depending on the mobile device, to the pole. Find information on the different types of pole holders in the Leica Zeno GIS Equipment List
2. Clip the mobile device into the pole holder.
3. Switch on the mobile device.
4. Download and install Zeno Connect from the respective App Store or from myWorld.
5. Start the Zeno Connect app.
6. Insert the battery into the GG04 plus.
7. Press the ON/OFF key on the GG04 plus to switch on.
8. Screw the GG04 plus to the top of the pole.
9. On the mobile device, select the GG04 plus in the Zeno Connect app and connect to the GG04 plus through Bluetooth.

The position information can now be used within your third-party application. For more information, refer to the according Zeno Connect documentation, which is available on myWorld.

3.4

Connection with Leica Zeno GIS Software

Description

The GG04 plus is fully supported from:

- Zeno Field V3.6 onwards
- Zeno Mobile V1.9 onwards
- Zeno Connect V3.0 onwards (on Windows 7/8/10, Android version > 4.1 or iOS)

Consult the corresponding documentation from myWorld for detailed help with software installation and instructions. Here only the basic idea behind and the connection to Zeno Connect on third-party devices is explained.



On Windows 7 devices, the first initial pairing might take up to several minutes.

Principle of Zeno Connect

Zeno Connect is the configuration software for your Leica GG04 plus Smart Antenna. With Zeno Connect the highly accurate position achievable with the GG04 plus antenna can be utilised by location aware applications running on iOS, Android or Windows.

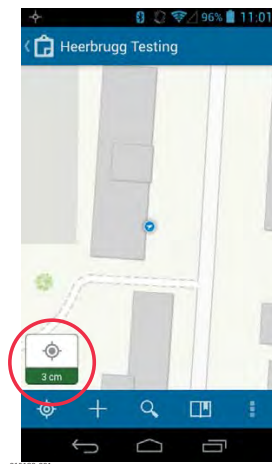

Different versions available for Zeno Connect

There are three different versions of Zeno Connect available. One for iOS, one for Android and one for Windows.

Zeno Connect for iOS and Android is available for download from the respective App Stores. A valid internet connection is necessary. Unlike the Windows Zeno Connect version, a license for Zeno Connect on Android smartphones and tablets or iPhone and iPad is included with the GG04 plus antenna purchase.

Zeno Connect for Windows can be downloaded from myWorld, including installation instructions and user manual.

Using Zeno Connect on Android smartphones and tablets

Zeno Connect on Android utilizes the so-called Android Location Manager. It allows every location aware app installed on your device to utilize the highly accurate GNSS position.

Install Zeno Connect

Install Zeno Connect from the Google Play Store.

On the first startup Zeno Connect checks if the GPS is switched on. If this is not the case you are guided to the correct setting.

Furthermore, Zeno Connect verifies that it is set as the mock-location app. This setting has to be enabled only once. It can be achieved by following these steps:

Enable Mock Location

Activate the **Developer options** first in order to enable **Mock Location**.

1. Tap **OK** to enter the Android settings page, when Zeno Connect is asking for it.

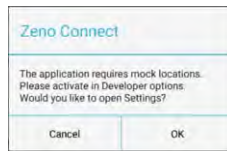

2. Scroll to and tap **About phone** in the Android Settings page.
3. Scroll to and tap **Build number** seven times. A message saying that **Developer options** have been activated is displayed.
4. Go back to the Settings page. Tap on **Developer options** and turn them on.
5. Scroll to the **Mock Location** section and turn it on. Depending on the device manufacturer, it is also possible that you can define which app should be used as the **Mock Location** app. If this is the case, select Zeno Connect.
6. A device restart is recommended to ensure that the settings are enabled.

Connect the GG04 plus antenna

Once the setup is correct, connect the GG04 plus antenna within the Zeno Connect settings.

As soon as a connection is established, the position information from the GG04 plus is automatically used by any location aware app running on your device.

For more detailed information about Zeno Connect settings and antenna configuration, refer to the respective documentation.

In case further GNSS metadata is required, some apps allow to establish a direct connection to the GG04 plus antenna by a Bluetooth connection. It allows reading NMEA messages directly from the antenna in order to obtain additional GNSS meta information. Consult the respective app documentation on how to do this. Zeno Connect is still required to configure the antenna and to provide correction data.

Using Zeno Connect on iPhone, and iPad

The GG04 plus can be connected by Bluetooth settings to an iPhone, or iPad. Any location aware app can immediately use the uncorrected, navigated position coming from the antenna. For a more accurate position, Zeno Connect has to be utilised.

Pair the antenna with your iPhone, or iPad using the iOS Bluetooth settings. In case Zeno Connect is not yet installed on the device, a pop up is displayed, which guides you automatically to Zeno Connect in the App Store.

Install and start Zeno Connect to configure and to provide correction data to the antenna. The high accuracy position is then automatically used by any location aware app running on the Apple device.

For more detailed information about Zeno Connect settings and antenna configuration, refer to the respective documentation.

In case further GNSS metadata is required, some apps allow you to establish a direct connection to the GG04 plus antenna by a SPP Bluetooth connection. It allows reading NMEA messages coming directly from the antenna in order to obtain additional GNSS meta information. Consult the respective app documentation on how to do this. Zeno Connect is still required to configure the antenna and to provide correction data.

 The GG04 plus GNSS metadata feature is restricted and it might not yet be possible in your app to connect to the additional SPP Bluetooth port of the antenna. If this feature is needed, ask the app developer to contact the Leica Zeno team for approval and integration guidance (zeno.support@leica-geosystems.com).

3.5

Correction Service Spot Lite and Spot Prime (PPP)

Description

Spot Lite and Spot Prime are correction services supported by the GG04 plus antenna.

Both are subscription services with the correction data being received from a satellite. Therefore, this service is an ideal solution for precise applications in areas where mobile data connection is unavailable or unreliable and real-time high accuracy is necessary.

With the correction service, the position accuracy will be enhanced autonomously after a necessary convergence time.

- 10 cm and better level for Spot Prime.
- 60 cm and better level with the Spot Lite service.

The convergence phase can take up to 30 minutes to have a converged solution with the Spot Prime option and up to seven minutes for Spot Lite.



A Multi-frequency option is necessary to use the different Spot options.

Service activation

After ordering the subscription service, activate the respective Spot option once within 30 days of the order date. To complete the activation process, switch on the antenna and leave it running in very good GNSS conditions for up to three hours. A stable tracking of one of the PPP satellites is necessary for the initial activation. Once the activation is completed, it's possible to use the Spot option to improve the positioning quality.

Service usage

After the initial Service activation, the Spot option can be activated like any other correction service. After activation, the convergence period begins, where the position accuracy is gradually improving over time until the best possible position accuracy is achieved.

The tracking of at least one correction satellite is necessary to receive a corrected GNSS position, during both the convergence period and spot usage.

4 Care and Transport

4.1 Transport

Transport in a road vehicle

Never carry the product loose in a road vehicle, as it can be affected by shock and vibration. Always carry the product in its container, original packaging or equivalent and secure it.

Shipping

When transporting the product by rail, air or sea, always use the complete original Leica Geosystems packaging, container and cardboard box, or its equivalent, to protect against shock and vibration.

Shipping, transport of batteries

When transporting or shipping batteries, the person responsible for the product must ensure that the applicable national and international rules and regulations are observed. Before transportation or shipping, contact your local passenger or freight transport company.

4.2 Storage

Product

Respect the temperature limits when storing the equipment, particularly in summer if the equipment is inside a vehicle. Refer to "5 Technical Data" for information about temperature limits.

Li-Ion batteries

- Refer to "5 Technical Data" for information about storage temperature range.
- Remove batteries from the product and the charger before storing.
- After storage recharge batteries before using.
- Protect batteries from damp and wetness. Wet or damp batteries must be dried before storing or use.
- A storage temperature range of 0 °C to +30 °C / +32 °F to +86 °F in a dry environment is recommended to minimize self-discharging of the battery.
- At the recommended storage temperature range, batteries containing a 40% to 50% charge can be stored for up to one year. After this storage period the batteries must be recharged.

4.3 Cleaning and Drying

Product and accessories

- Use only a clean, soft, lint-free cloth for cleaning. If necessary, moisten the cloth with water or pure alcohol. Do not use other liquids; these may attack the polymer components.

Damp products

Dry the product, the container, the foam inserts and the accessories at a temperature not greater than 40 °C/104 °F and clean them. Remove the battery cover and dry the battery compartment. Do not repack until everything is dry. Always close the container when using in the field.

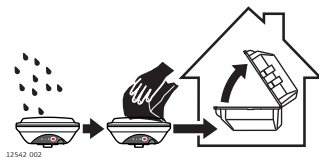

Cables and plugs

Keep plugs clean and dry. Blow away any dirt lodged in the plugs of the connecting cables.

5 Technical Data

5.1 Tracking Characteristics GG04 plus

Satellite reception Multi-frequency

Instrument channels  Depending on the satellite systems and signals configured, a maximum number of 555 channels is allocated.

Supported signals

System	Signal
GPS	L1 C/A, L2P, L2C, L5
GLONASS	L1, L2
Galileo	E1, E5a, E5b, AltBOC, E6*
BeiDou	B1, B2, B3*
QZSS	L1, L2C, L5
L-Band	for PPP corrections by satellite
SBAS	EGNOS, WAAS, MSAS, GAGAN

* Believe to comply, but subject to availability of BeiDou ICD and Galileo commercial service definition. BeiDou B3 and Galileo E6 will be provided through future firmware upgrade.

Initialisation time (typical)

Cold start [s]	Warm start [s]
< 40	< 30

Signal reacquisition time (typical)

< 1 s

5.2 Accuracy

 Accuracy is dependent upon various factors including the number of satellites tracked, constellation geometry, observation time, ephemeris accuracy, ionospheric disturbance, multipath and resolved ambiguities.

The following accuracies, given as **root mean square**, are based on measurements processed using Zeno Office and on real-time measurements.

The use of multiple GNSS systems can increase accuracy by up to 30% relative to GPS only.

Post-processed accuracy

Type	Accuracy
Baseline mode L1 Phase	10 mm + 1 ppm RMS*

* Measurement precision, accuracy and reliability depend upon various factors including number of available satellites, geometry proximity to base station, multipath effects or ionospheric conditions.

Horizontal real-time accuracy

SBAS, PPP or external source.

Type	Accuracy
SBAS, L1 only	< 0.9 m*
Spot Lite, PPP (Multi-frequency option needed)	< 60 cm*, after approximately seven minutes of converging
DGNSS, L1 only	< 40 cm*
Spot Prime, PPP (Multi-frequency option needed)	< 10 cm*, after approximately 30 minutes of converging
RTK, Multi-frequency	< 1 cm + 1 ppm*

* Measurement precision, accuracy and reliability depend upon various factors including number of available satellites, geometry proximity to base station, multipath effects or ionospheric conditions.

Vertical real-time accuracy

Type	Accuracy
RTK, Multi-frequency	< 2 cm + 1 ppm*

* Measurement precision, accuracy and reliability depend upon various factors including number of available satellites, geometry proximity to base station, multipath effects or ionospheric conditions.

5.3

Technical Data

Dimensions	Height:	0.071 m
	Diameter:	0.186 m
Weight	0.8 kg including internal battery	
Connector	LEMO-1:	female, 8 pin
Mounting	5/8" Whitworth	
Power	Power consumption:	2.0 W typically
Internal battery	Type:	Li-Ion
	Voltage:	7.4 V
	Capacity:	GEB212 - 2.6 Ah
	Typical operating time*:	GPS only - 10 h RTK (GPS and GLONASS) - 7.5 h
* May vary with temperature, battery age, usage or available GNSS options.		
Bluetooth	Type:	Bluetooth 4.1
GNSS antenna	Type	GG04 plus
	Frequency For Frequency, refer to the "Frequency band" in chapter "5.4 Conformity to National Regulations"	

Type	GG04 plus
Gain (LNA)	Typically 28 dB
Noise Figure	Typically < 2 dB

Environmental specifications

Type	Operating temperature [°C]	Storage temperature [°C]
Instrument	-40 to +65 Bluetooth: -30 to +65	-40 to +80
GEB212	-20 to +55	-40 to +70

External influences	Protection
Water, dust and sand	IP68 (IEC60529) Protected against continuous immersion in water. Tested for 2 hours in 1.40 m depth. Dust tight.
Humidity	Up to 100%. Periodically drying out the instrument effectively counteracts the effects of condensation.

Serial ports

Description	Default setting
Baud rates 4800–230400 baud, without RTS/CTS	115200/N/8/1/N

5.4

Conformity to National Regulations

Conformity to national regulations

- FCC Part 15 (applicable in US)
- Hereby, Leica Geosystems AG, declares that the radio equipment type GG04 plus is in compliance with Directive 2014/53/EU and other applicable European Directives. The full text of the EU declaration of conformity may be consulted at <http://www.leica-geosystems.com/ce>.



Class 1 equipment according European Directive 2014/53/EU (RED) can be placed on the market and be put into service without restrictions in any EEA Member state.

- The conformity for countries with other national regulations not covered by the FCC part 15 or European directive 2014/53/EU has to be approved prior to use and operation.
- Japanese Radio Law and Japanese Telecommunications Business Law Compliance.
 - This device is granted pursuant to the Japanese Radio Law (電波法) and the Japanese Telecommunications Business Law (電気通信事業法).
 - This device should not be modified (otherwise the granted designation number will become invalid).

Frequency band

Type	Frequency band [MHz]
GG04 plus	GPS, QZSS L1: 1575.42 GPS, QZSS L2: 1227.60 GPS, QZSS L5: 1176.45 GLONASS L1: 1602.5625-1611.5 GLONASS L2: 1246.4375-1254.3 Galileo E1: 1575.42 Galileo E5a: 1176.45 Galileo E5b: 1207.14 Galileo E6: 1191.795 BeiDou B1: 1561.098 BeiDou B2: 1207.14
Bluetooth	2402...2480

Output power

Type	Output power [mW]
GNSS	Receive only
Bluetooth	max. 10 (Class 1)

Antenna

Type	Antenna	Gain [dBi]	Connector	Frequency band [MHz]
GNSS	Internal GNSS antenna element (receive only)	-	-	-
Bluetooth	Internal Microstrip antenna	1.0	-	-

5.4.1

Dangerous Goods Regulations

Dangerous Goods Regulations

Many products of Leica Geosystems are powered by Lithium batteries.

Lithium batteries can be dangerous under certain conditions and can pose a safety hazard. In certain conditions, Lithium batteries can overheat and ignite.

👉 When carrying or shipping your Leica product with Lithium batteries onboard a commercial aircraft, you must do so in accordance with the **IATA Dangerous Goods Regulations**.

👉 Leica Geosystems has developed **Guidelines** on "How to carry Leica products" and "How to ship Leica products" with Lithium batteries. Before any transportation of a Leica product, we ask you to consult these guidelines on our web page (<http://www.leica-geosystems.com/dgr>) to ensure that you are in accordance with the IATA Dangerous Goods Regulations and that the Leica products can be transported correctly.

👉 Damaged or defective batteries are prohibited from being carried or transported onboard any aircraft. Therefore, ensure that the condition of any battery is safe for transportation.

Software Licence Agreement

This product contains software that is preinstalled on the product, or that is supplied to you on a data carrier medium, or that can be downloaded by you online according to prior authorisation from Leica Geosystems. Such software is protected by copyright and other laws and its use is defined and regulated by the Leica Geosystems Software Licence Agreement, which covers aspects such as, but not limited to, Scope of the Licence, Warranty, Intellectual Property Rights, Limitation of Liability, Exclusion of other Assurances, Governing Law and Place of Jurisdiction. Please make sure, that at any time you fully comply with the terms and conditions of the Leica Geosystems Software Licence Agreement.

Such agreement is provided together with all products and can also be referred to and downloaded at the Leica Geosystems home page at <http://leica-geosystems.com/about-us/compliance-standards/legal-documents> or collected from your Leica Geosystems distributor.

You must not install or use the software unless you have read and accepted the terms and conditions of the Leica Geosystems Software Licence Agreement. Installation or use of the software or any part thereof, is deemed to be an acceptance of all the terms and conditions of such Licence Agreement. If you do not agree to all or some of the terms of such Licence Agreement, you must not download, install or use the software and you must return the unused software together with its accompanying documentation and the purchase receipt to the distributor from whom you purchased the product within ten (10) days of purchase to obtain a full refund of the purchase price.

Appendix A

Firmware Upgrade

Upgrading firmware for the GG04 plus



Upgrading firmware can take some time. Do not interrupt the power of the device during firmware upgrade! Ensure that the battery is at least 75 % full before beginning the upgrade.



GG04 plus firmware can only be uploaded from a Windows computer or laptop.

1. Download the most recent GG04 plus firmware from <https://myworld.leica-geosystems.com>.
 2. Download the Leica Zeno FW loader from <https://myworld.leica-geosystems.com>.
 3. Connect the GG04 plus to your computer by Bluetooth.
 4. Use Leica Zeno Firmware Upload Tool to upgrade the latest firmware version. Refer to the corresponding software documentation on how to connect the instrument to your device and how to use Leica Zeno GIS Tools.
-

Appendix B Pin Assignments and Sockets

Description

Some applications require knowledge of the pin assignments for the instrument ports.

In this chapter, the pin assignments and sockets for the instrument ports are explained.

Port at the instrument underside



a Lemo port (USB and serial)

Pin assignments for 8 pin LEMO-1

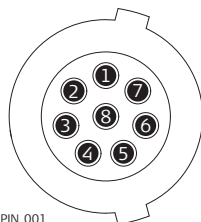

Pin	Signal Name	Function	Direction
1	USB_D+	USB data line	In or out
2	USB_D-	USB data line	In or out
3	GND	Signal ground	-
4	RxD	RS232, receive data	In
5	TxD	RS232, transmit data	Out
6	NC	Not connected	-
7	PWR	Power input, 10.5 V-28 V	In
8	AUX_ON	RS232, manual PWR switch	In

Sockets

8 pin LEMO-1: LEMO-1, 8 pin, LEMO EGI.1B.308.CLN

868033-1.0.0en

Original text

Published in Switzerland

© 2018 Leica Geosystems AG, Heerbrugg, Switzerland

Leica Geosystems AG

Heinrich-Wild-Strasse
CH-9435 Heerbrugg
Switzerland
Phone +41 71 727 31 31

www.leica-geosystems.com



- when it has to be **right**

Leica
Geosystems